

Absolute Maximum Ratings

| Parameter | Value | Unit |
|-------------------------------|----------|------|
| Max DC Voltage Applied | 150 | V |
| Max Power Dissipation at 25°C | 150 | mW |
| Ambient Temperature | -30 ~ 70 | °C |



Electrical Characteristics at 25°C

| Parameter | Symbol | Value | Unit |
|---------------------------|-----------------|-----------|------|
| Light Resistance at 10Lux | R ₁₀ | 16 ~ 36 | KΩ |
| Dark Resistance Min. | R _d | 2.0 | MΩ |
| Gamma at (100-10)Lux | γ(100/10) | 0.7 ± 0.1 | |
| Spectral Peak | | 560 | nm |
| Rise Time | T _R | 30 | ms |
| Decay Time | T _F | 30 | ms |

Package dimensions (Unit:mm)

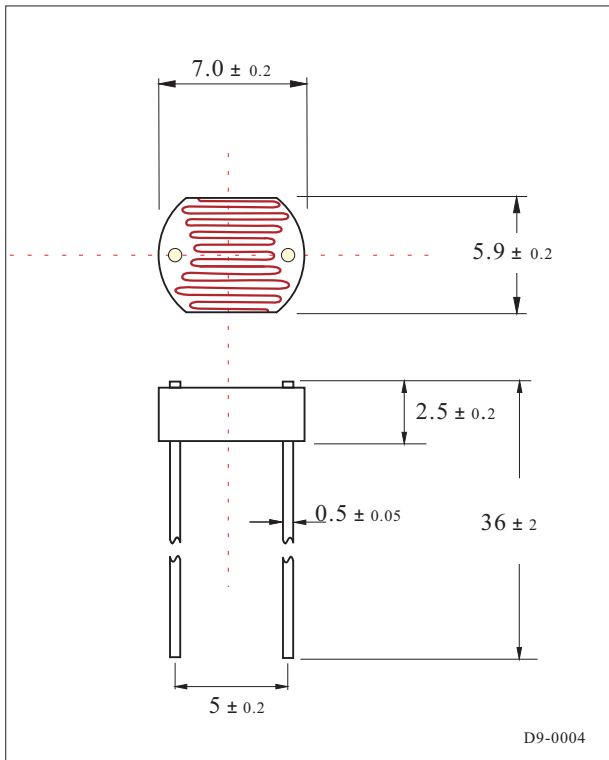

Illuminance vs Photo Resistance

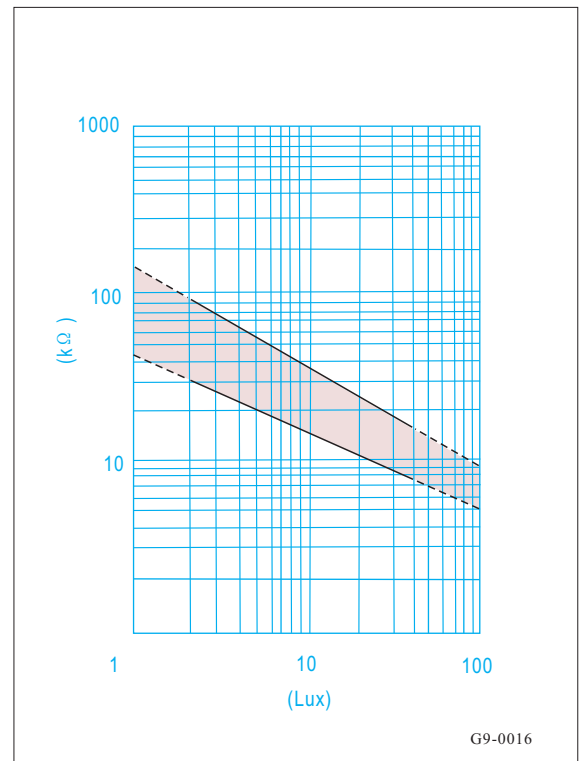

* Photocells are tested at 10 Lux. Other values shown in the tables are for reference only.

* Specification subject to change without notice