

### Absolute Maximum Ratings

Parameter	Value	Unit
Max DC Voltage Applied	150	V
Max Power Dissipation at 25°C	150	mW
Ambient Temperature	-30 ~ 70	°C



### Electrical Characteristics at 25°C

Parameter	Symbol	Value	Unit
Light Resistance at 10Lux	R <sub>10</sub>	3 ~ 20	KΩ
Dark Resistance Min.	R <sub>d</sub>	0.5	MΩ
Gamma at (100-10)Lux	γ(100/10)	0.7 ± 0.1	
Spectral Peak		560	nm
Rise Time	T <sub>R</sub>	30	ms
Decay Time	T <sub>F</sub>	30	ms

### Package dimensions (Unit:mm)

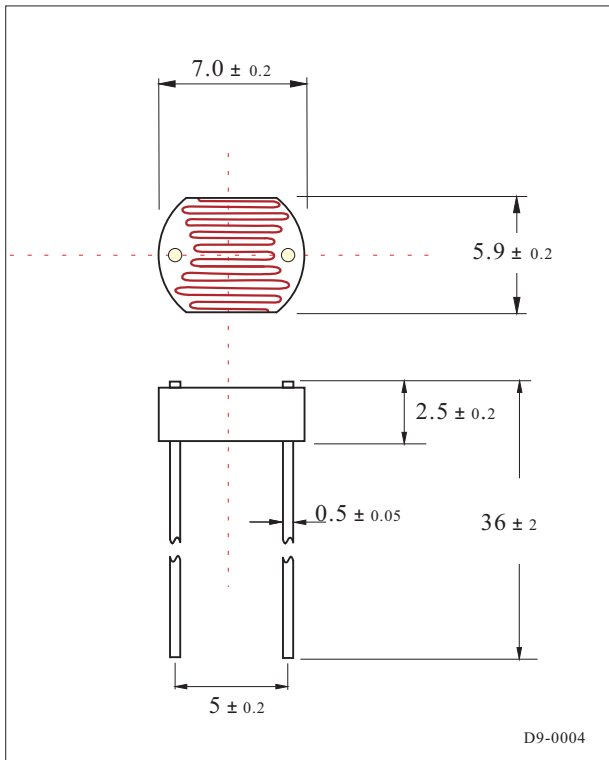

### Illuminance vs Photo Resistance

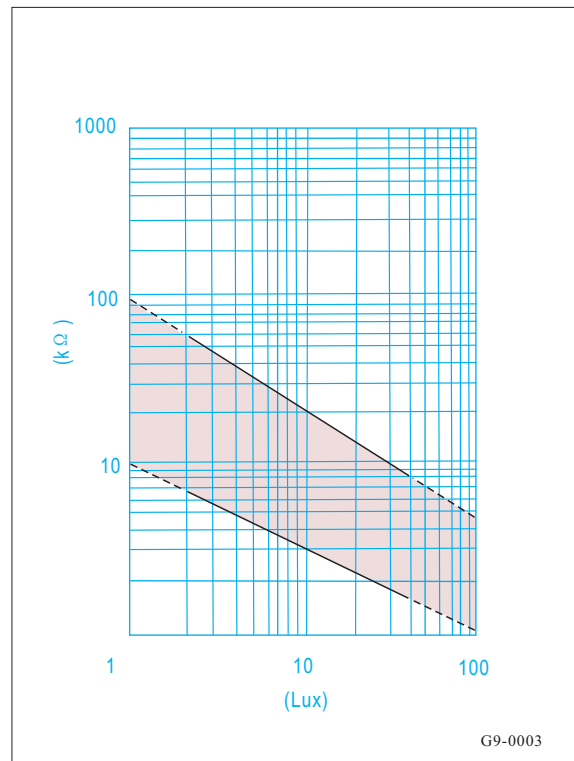

\* Photocells are tested at 10 Lux. Other values shown in the tables are for reference only.

\* Specification subject to change without notice